

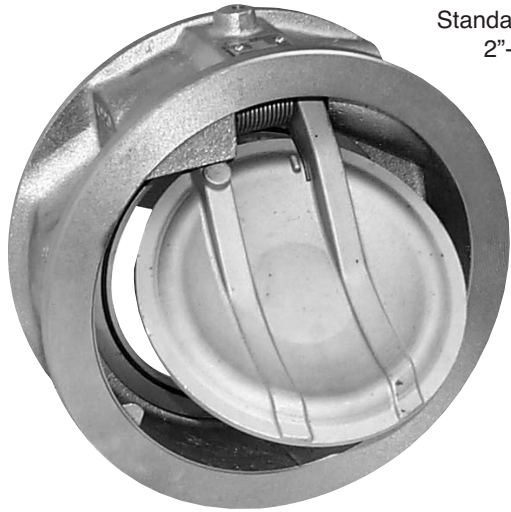

Series 501A

Wafer Swing Check Valve



Standard Style
2"-12"

- **Low Head Loss**
- **Watertight Nitrile Seat**
- **Spring Assisted, Fast Closure**
- **Extremely Light Weight**

DESCRIPTION

Cla-Val Series 501A Wafer Swing Check Valve has a quick, spring-assisted closure that minimizes the possibility of water hammer. The swing check design offers low head loss and a full-flow passageway making it ideal for water or wastewater applications. The short lay length of the valve allows for a space-saving design. It is available in sizes 2" to 30", with either a 125 lb. or 150 lb. pressure class rating.

Available in a variety of materials, including all 316 stainless steel, the Cla-Val Wafer Swing Check Valve uses a standard soft seat to ensure a drip-tight seal. For ease of installation, valves 6" and larger are supplied with a tapped hole to mount an eye bolt for lifting. All materials conform to ASTM specifications, ensuring performance reliability.

SPECIFICATIONS

The wafer swing check valve shall have torsional a spring-assisted fast closure to minimize possibility of water hammer. The valve shall be constructed of either cast iron or steel body.

The body shall have a machined dovetail groove to retain a field replaceable Nitrile (Buna-N®) Seal that provides water-tite shut-off at low/high pressure

The valve disc/arm assembly shall be one piece design utilizing an integral disc arm for connection to the shaft for positive shut-off and no disc flutter.

For corrosion resistance the valve shall be Electroless Nickel Plated

Valve Body:

- 2" - 12" Cast Iron ASTM A48
Electroless-Nickel Plated
- 14" - 30" Carbon Steel ASTM A216 WCB
Electroless-Nickel Plated

Valve Trim:

- 2" - 12" 316 Stainless Steel ASTM A23,
14" - 30" Carbon Steel ASTM A216 WCB
Electroless-Nickel Plated
- Seat O-ring: Nitrile, Other Seat Materials Available

All materials conform to ASTM specifications, The valve shall be a Cla-Val Series 501A Wafer Swing Check Valve, Newport Beach, CA 92659-0325

Typical Applications with Correct Valve Location

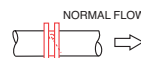
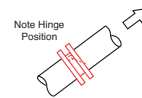
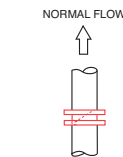
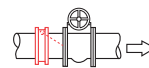
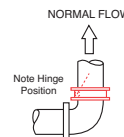
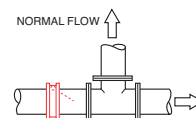

Avoid These Applications with Incorrect Valve Location

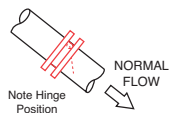
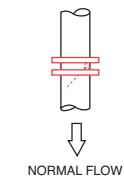
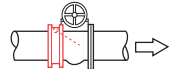
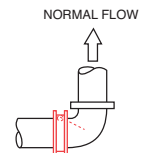
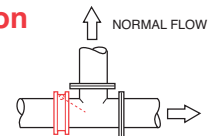

Note: Allow minimum (2) pipe diameters clearance downstream of check valve with disc open to promote smooth flow

Recommendations for Installation Position

1. Install the valve in horizontal or upward flow for proper valve closure.
- Caution: Do not use with reciprocating compressors, or in other pulsating services.

Series 501A - Wafer Swing Check Valves (Standard) 2" - 12"

Dimensions (In Inches)

Size	A	B	C	D	E (Deg.)	Q	Wt.Lbs.
2	4 1/4	1 11/16	1 3/8	1 3/16	59	2	3.1
2 1/2	4 3/4	1 13/16	1 3/4	1 1/16	60	2 1/2	4.2
3	5 1/4	2 1/2	2 3/8	1 1/2	62	3	6.6
4	6 1/4	2 1/2	3 3/8	1 5/8	60	4	8.1
5	7 1/4	2 3/4	3 3/8	2 1/2	61	5	12.3
6	8 3/4	3	4 1/2	3 3/4	72	6	18
8	11	3 1/2	6 1/4	4 3/4	70	7 3/4	27.3
10	13 3/8	4 1/2	7 3/8	5 3/4	66	9 3/4	51.3
12	16 1/8	4 1/2	9 1/2	7 3/8	65	11 3/4	72.6

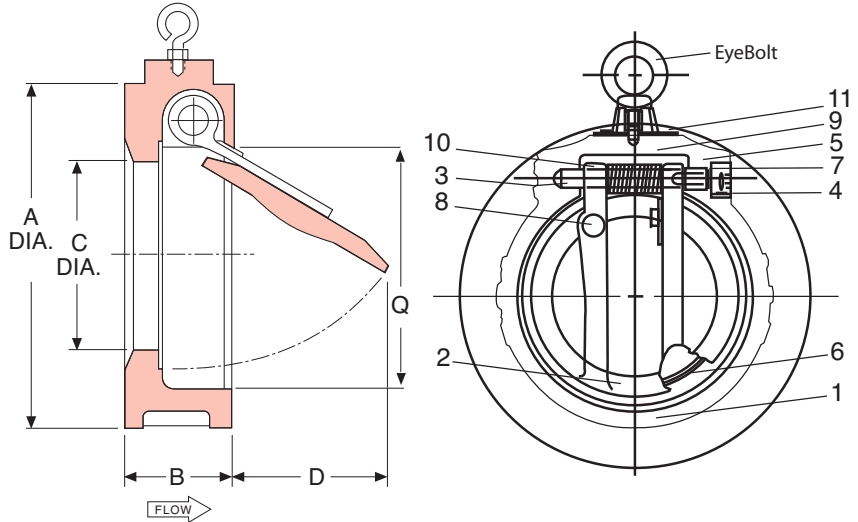

No.	Description	Material	Specifications
1	Body	Cast Iron or Steel	ASTM A48 / ASTM A216
2	Disc	316 Stainless Steel	ASTM A473 / A743M - CF8M
3	Shaft	316 Stainless Steel	ASTM A276
4	Plug	304 Stainless Steel	ASTM A276
5	Seat (Shaft)	PTFE	-
6	Seat (Body)	Nitrile or Viton™	Commercial
7	Bushing	316 Stainless Steel	ASTM A276
8	Travel Stop	316 Stainless Steel	ASTM A276
9	Tag	Aluminum	-
10	Spring	304 Stainless Steel	-

Technical Data

Pressure Rating: 235 Max psi

Temperature Range:- 5° to 210° F

Disc Cracking Pressure: All Valves equal approximately 0.5 psi

Fluids: Water, Wastewater, Chemicals and Petroleum

Series 501A Pressure Loss Curve

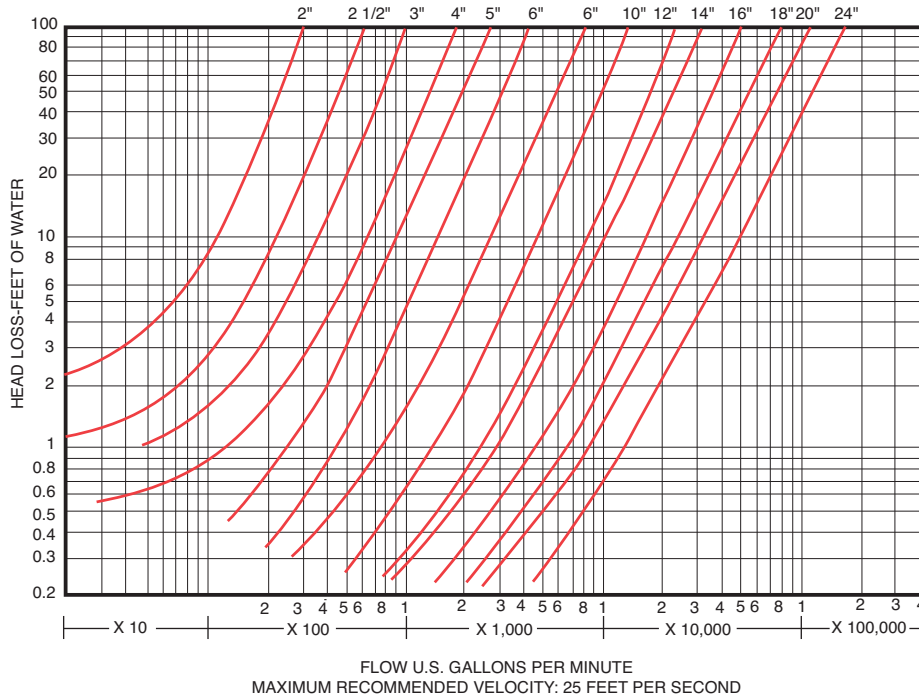

Be Informed:

Check valves are vital components of many systems. Their purpose is simple: to prevent the reversal of flow rather than stopping, starting, or throttling flow. Reverse flow may be merely a nuisance, or it can cause severe damage to equipment contamination of potable water supplies, or hazardous conditions resulting from the uncontrolled mixing of various fluids in pipelines.

When Ordering, Please Specify

1. Catalog No. 501A
2. Valve Size
3. Seat O-Ring Material
4. Body & Trim Material

** 30" Consult Factory

Valve Size	Inches	2	2 1/2	3	4	5	6	8	10	12	14	16	18	20	24	30
	mm		50	65	80	100	125	150	200	250	300	350	400	450	500	610
Cv Factor	Gal/Min	61	116	208	325	551	843	1640	2702	3996	5732	8548	11846	14327	22132	**
	Liters/Sec	3.85	7.32	13.12	20.5	34.76	53.18	103.47	170.47	252.11	361.63	539.29	747.36	903.89	1396.31	**

Series 501A - Wafer Swing Check Valves (Compact) 14" - 30"

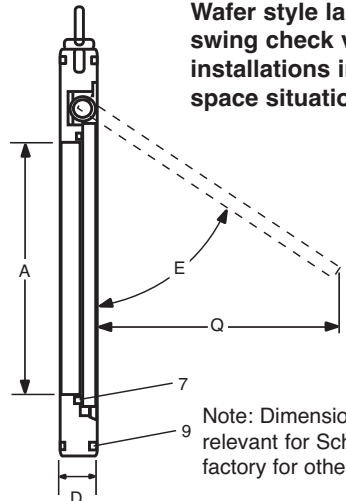
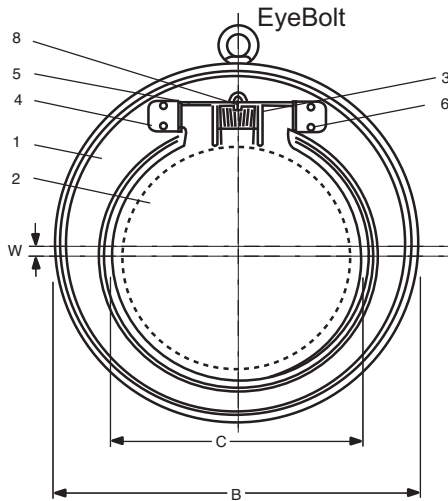

Wafer style large diameter swing check valves for installations in minimum space situations.

Features

- The compact wafer thin body provides extreme low weight.
- Minimum width of body allows installation between various flange standards.
- Seating O-Ring placed in groove on body and is easily replaceable.
- Low pressure shut-off, even at very low differential pressure; due to disc rotational axis location; which fully closes the valve.

Note: Dimensions E & Q are only relevant for Sch. 40 pipe. Consult factory for other pipe I.D.

Dimensions (Inches)

Size	A	B	C	D	E (Deg.)	Q	W	Wt.Lbs.
14	10 ½	17 ½	11 ½	1 ½	56	10	5/8	40
16	12	20 ½	13 ¼	2	56	11 ½	13/32	58
18	14	21 ½	15	2	52	12 ½	13/32	69
20	16	23 ¾	17	2 ½	49	13 ½	11/16	110
24	19	28 ½	20 ½	3	47	15 ¾	11/16	162
30	25	35	26 ½	3	44	19 ½	11/16	290

Note: Q = Is the maximum dimension the disc extends from the face of the valve
 K_V = The flow rate of water in gpm that passes through a valve with a pressure drop of 1 bar (14.5 psi) @68° F.
 $K_V = C_V / 1.168$
 Dimensions are moninal in $\pm 1/8"$
 W = Is the offset between the disc centerline and the valve centerline.

No.	Description	Material	Specifications
1	Body*	Carbon Steel (Electro-Galvanized Plated)	AS1204 Grade 250
2	Disc*	Carbon Steel (Electro-Galvanized Plated)	AS1204 Grade 250
3	Shaft	316 Stainless Steel	ASTM A276 UNS S31600
4	Pivot Block	304 Stainless Steel	ASTM A276 UNS S31600
5	Washer	316 Stainless Steel	AISI 316 Stainless Steel
6	Cap screws	316 Stainless Steel	AISI 316 Stainless Steel
7	Seat O-Ring	Buna-N® (Standard)	Viton™ (Optional)
8	Spring	316 Stainless Steel	ASTM A316
9	Flange O-Ring #	Buna-N® (Standard)	Viton™ (Optional)

Note: * Other Materials Available.
 # Denotes flange O-Ring material is matched to Seat O-Ring

Technical Data

Sizes: 14" - 30"
Pressure Rating: 235 psi
Temperature Range:
 5° to 210° F
 Buna-N®: -18°C - 100°C
 Viton™: -20°C - 190°C
Flange Type: ANSI 150 (flat faced)

Note: Valves 14" - 30" have integral O-Ring flange Seals, Gaskets are not required for installation and should not be used.

General Application

A valve for wastewater, fire protection systems, municipal water systems, natural gas systems and HVAC Systems.

501A Pressure Drop vs Flow Rate

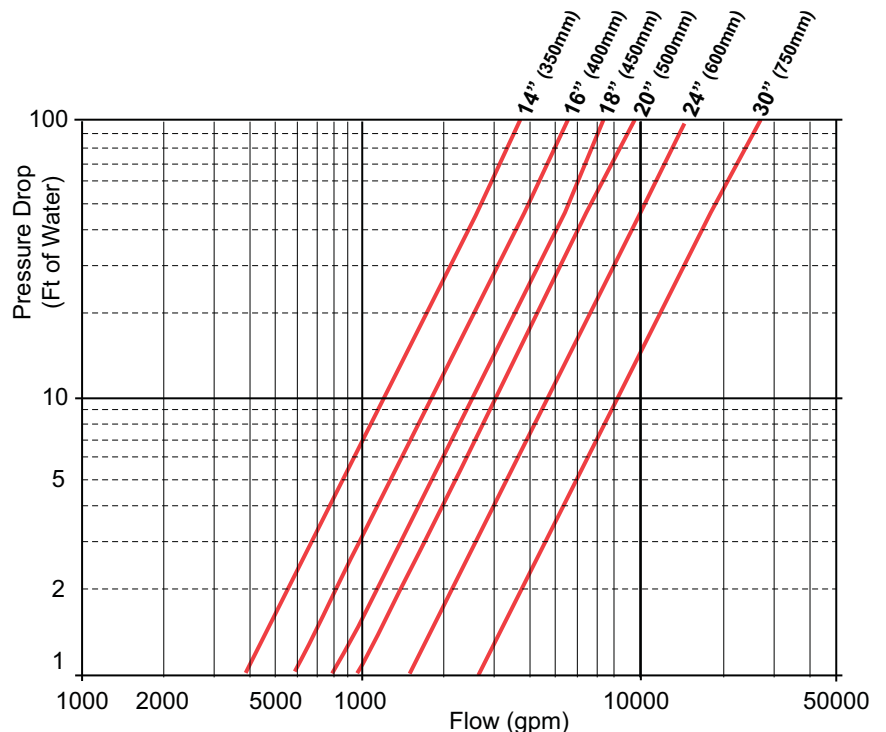

501A Wafer Swing Check Valve

	Feature
●	1. Lowest initial cost
●	2. Shortest lay length
●	3. Lowest head loss (see head loss curves)
●	4. Resilient seat (standard)
●	5. For waste and raw sewage
●	6. For Clean water
●	7. Buried service
●	8. Vertical installation flow up only
●	9. Flow Velocities up to 25 FPS

Typical Applications with Correct Valve Location

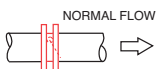
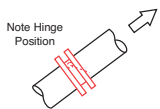
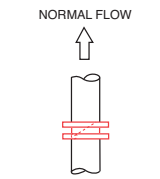
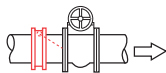
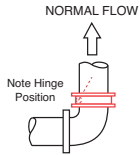
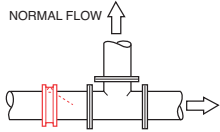

Recommendations for Installation Position

1. Install the valve in horizontal or upward flow for proper valve closure.
Caution: Do not use with reciprocating compressors, or in other pulsating services.

Note: Allow minimum (2) pipe diameters clearance downstream of check valve with disc open to promote smooth flow.

INSTALLATION

Wafer style check valves are designed to fit between ANSI Class 125 and Class 150 flat faced flanges. Two standard flange gaskets are recommended when installing 2" - 12" 501A valves. 14" and larger 501A valves do not require gaskets. Determine minimum bolt or stud length by adding check valve length to ANSI bolt or stud length.

Check Valve Length is Dimension B for 2" - 12" and Dimension D for 14" - 30" valves. ANSI bolt or stud length can be found in the following standards: For Class 125 use AWWA/ANSI standard B16.1. For Class 150 use AWWA/ANSI standard B 16.5.

Avoid These Applications with Incorrect Valve Location

